

SHORTENING THE TRACK

Position the track with the blanking plate on your right, 'front' facing you.

Remove all the gliders (6) from the track. This is done by removing the locking plates (5).

The gliders will now slide out easily at each end of the track.

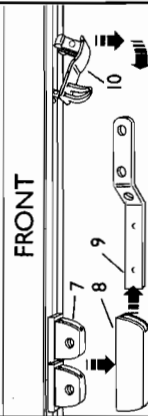

Pull out the Overlap Arm (9) from the fixed carrier (7) and slide off carrier cover (8).

Remove the floating carrier (10) by lifting the flat end from the track, then twisting the carrier through 90 degrees.

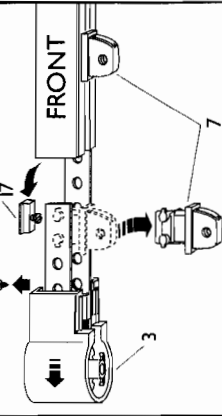

Loosen the crosshead screw holding the left hand pulley housing (3) and pull this gently away from the track. The two sections of the fixed carrier (7) will now start to separate.

Loosen stack back stop locking screw and slide back stop (17) out of the end of the track.

Continue to pull left hand pulley housing away until one section of the fixed carrier is clear of the track.

Unclip this section of fixed carrier (7) from the tape, then withdraw tape from pulley housing (3).

Now undo pulley housing (3) on your right. Move pulley housing (3) and tape together away from track until all the tape is completely clear of the track.

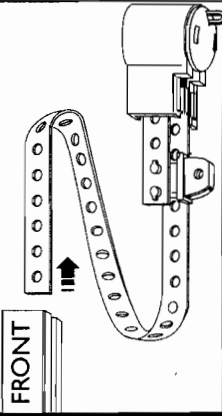

CUTTING THE TRACK

The track can now be cut to the required length using a hacksaw. On 2-Piece tracks, cut equally away from each pulley housing end of track to ensure joint remains central. Take care to ensure a square cut. Remove any burrs using sandpaper.

Follow drawings carefully, it is essential that the fixed carriers are fitted into the front channel of the track.

To re-assemble the track, feed the end of the tape without the fixed carrier, all the way through the rear track channel until it appears at the left hand end of the track.

Feed the tape end with fixed carrier (7) through the front track channel until you can re-secure the right hand pulley housing (3) to the track, then tighten the crosshead holding screw.

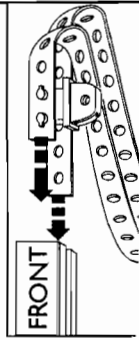

CUTTING THE TAPE

Before cutting tape, align the fixed carrier (7), which is still attached to the tape, to the end of the track. Compare your new overall track length to chart A. Mark projecting tape with both measures as shown.

Cut the tape at the midpoint between two holes which is within the min. and max. marks - if no midpoint occurs, shorten the track by 4mm and try again.

REASSEMBLING THE TRACK

Now feed the cut end of tape into the back slot of pulley housing (3) until tape re-appears. Rotate pulley wheel to assist if required.

Clip fixed carrier (7) to inside edge of tape and feed into front track channel.

Re-insert stack back stop (17). **Do not tighten.** Re-fasten pulley housing (3) to track.

TAPE TENSION CHECK

Squeeze both fixed master carriers (7) together. When released they should spring apart leaving a gap. Measure the gap and refer to chart B. **NO GAP** - Tape is too long. Shorten by 1 hole and recheck. Repeat if necessary.

GAP TOO LARGE - Tape is too short. Shorten track. *Note: shortening the track by 1mm will decrease gap by 2mm.*

CAUTION: LEAVING THE GAP TOO LARGE OR TOO SMALL CAN DAMAGE THE TAPE OR AFFECT THE MOTORS PERFORMANCE.

Note: Under normal service conditions the drive tape can stretch slightly which decreases the gap from initial settings.

Replace fixed carrier cover (8) and overlap arm (9), refit gliders in equal numbers either side of the fixed carrier (7) making sure their points face the front of the track. Replace locking plates (5).

Re-position stack back stop (17) and tighten locking screw.

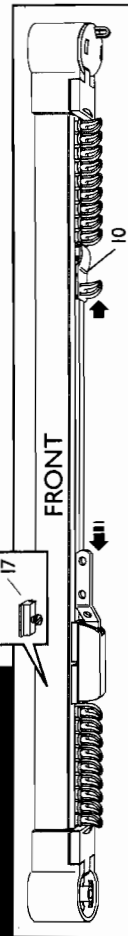

Slide the fixed carrier as far as it will go to the left hand end of the track.

Replace floating carrier (10) as close as possible to the right hand end of the track.

Your track is now ready to be fixed in position.

Return to  of the main fitting guide.

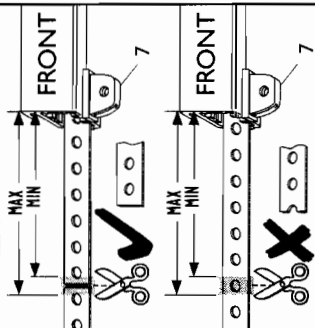

B

TRACK LENGTH (metres)	GAP	
	MIN (mm)	MAX (mm)
1 - 1.5	6	13
1.5 - 2	9	16
2 - 2.5	11	19
2.5 - 3	14	23
3 - 3.5	16	26
3.5 - 4	19	29
4 - 4.5	21	31
4.5 - 5	24	34

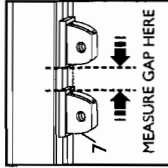

GAP TOO LARGE - Tape is too short. Shorten track. *Note: shortening the track by 1mm will decrease gap by 2mm.*

CAUTION: LEAVING THE GAP TOO LARGE OR TOO SMALL CAN DAMAGE THE TAPE OR AFFECT THE MOTORS PERFORMANCE.

Note: Under normal service conditions the drive tape can stretch slightly which decreases the gap from initial settings.

Replace fixed carrier cover (8) and overlap arm (9), refit gliders in equal numbers either side of the fixed carrier (7) making sure their points face the front of the track. Replace locking plates (5).

Re-position stack back stop (17) and tighten locking screw.

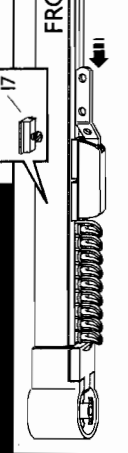

Slide the fixed carrier as far as it will go to the left hand end of the track.

Replace floating carrier (10) as close as possible to the right hand end of the track.

Your track is now ready to be fixed in position.

Return to  of the main fitting guide.

RE-ASSEMBLING THE TRACK

Position the track with the blanking plate on your right, 'front' facing you.

Remove all the gliders (6) from the track. This is done by removing the locking plates (5).

The gliders will now slide out easily at each end of the track.

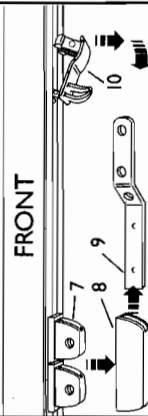

Pull out the Overlap Arm (9) from the fixed carrier (7) and slide off carrier cover (8).

Remove the floating carrier (10) by lifting the flat end from the track, then twisting the carrier through 90 degrees.

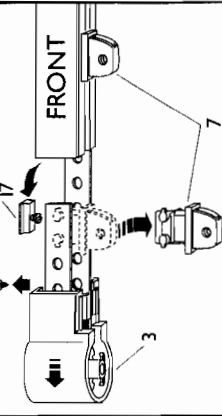

Loosen the crosshead screw holding the left hand pulley housing (3) and pull this gently away from the track. The two sections of the fixed carrier (7) will now start to separate.

Loosen stack back stop locking screw and slide back stop (17) out of the end of the track.

Continue to pull left hand pulley housing away until one section of the fixed carrier is clear of the track.

Unclip this section of fixed carrier (7) from the tape, then withdraw tape from pulley housing (3).

Now undo pulley housing (3) on your right. Move pulley housing (3) and tape together away from track until all the tape is completely clear of the track.

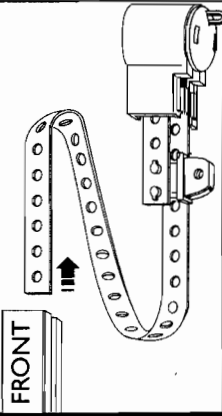

CUTTING THE TRACK

The track can now be cut to the required length using a hacksaw. On 2-Piece tracks, cut equally away from each pulley housing end of track to ensure joint remains central. Take care to ensure a square cut. Remove any burrs using sandpaper.

Follow drawings carefully, it is essential that the fixed carriers are fitted into the front channel of the track.

To re-assemble the track, feed the end of the tape without the fixed carrier, all the way through the rear track channel until it appears at the left hand end of the track.

Feed the tape end with fixed carrier (7) through the front track channel until you can re-secure the right hand pulley housing (3) to the track, then tighten the crosshead holding screw.

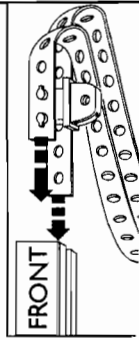

A

NEW TRACK LENGTH (metres)	TAPE PROJECTING	
	MIN (mm)	MAX (mm)
1 - 1.5	77	84
1.5 - 2	74	81
2 - 2.5	71	79
2.5 - 3	67	76
3 - 3.5	64	74
3.5 - 4	61	71
4 - 4.5	59	69
4.5 - 5	56	66